

Trench Gate Design Single IGBTMOD™ 600 Amperes/600 Volts

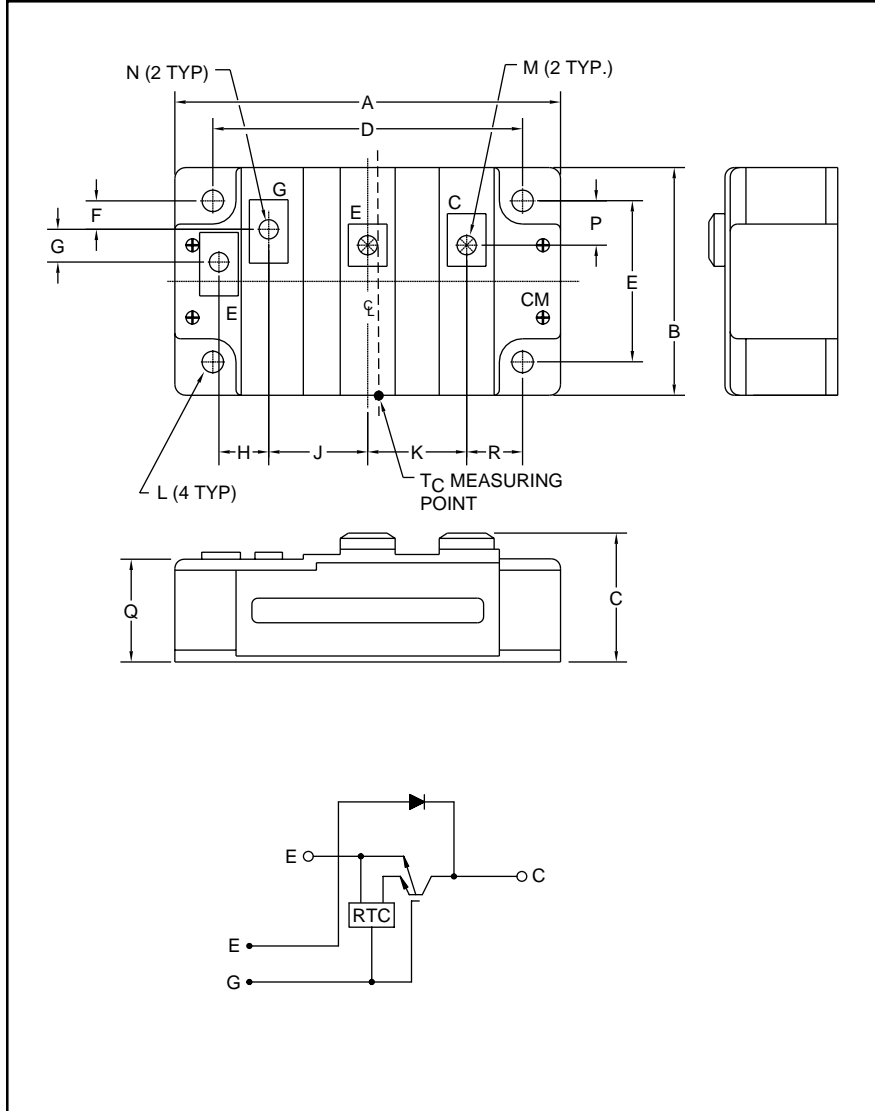

Outline Drawing and Circuit Diagram

Dimensions	Inches	Millimeters
A	4.21	107.0
B	2.44	62.0
C	1.34 +0.04/-0.02	34.0 +1.0/-0.5
D	3.66±0.01	93.0±0.25
E	1.88±0.01	48.0±0.25
F	0.37	9.5
G	0.39	10.0
H	0.53	13.5

Dimensions	Inches	Millimeters
J	1.02	26.0
K	1.14	29.0
L	0.26 Dia	6.5 Dia.
M	M8	M8
N	M4	M4
P	0.49	12.55
Q	1.02 +0.04/-0.02	26.0 +1.0/-0.5
R	0.81	20.5



Description:

Powerex IGBTMOD™ Modules are designed for use in switching applications. Each module consists of one IGBT Transistor in a single configuration with a reverse-connected super-fast recovery free-wheel diode. All components and interconnects are isolated from the heat sinking baseplate, offering simplified system assembly and thermal management.

Features:

- Low Drive Power
- Low $V_{CE(sat)}$
- Discrete Super-Fast Recovery Free-Wheel Diode
- Isolated Baseplate for Easy Heat Sinking

Applications:

- AC Motor Control
- UPS
- Battery Powered Supplies

Ordering Information:

Example: Select the complete module number you desire from the table - i.e. CM600HU-12F is a 600V (V_{CES}), 600 Ampere Single IGBTMOD™ Power Module.

Type	Current Rating Amperes	V_{CES} Volts (x 50)
CM	600	12



Powerex, Inc., 200 Hillis Street, Youngwood, Pennsylvania 15697-1800 (724) 925-7272

CM600HU-12F
Trench Gate Design Single IGBTMOD™
 600 Amperes/600 Volts

Absolute Maximum Ratings, $T_j = 25^\circ\text{C}$ unless otherwise specified

Ratings	Symbol	CM600HU-12F	Units
Junction Temperature	T_j	-40 to 150	$^\circ\text{C}$
Storage Temperature	T_{stg}	-40 to 125	$^\circ\text{C}$
Collector-Emitter Voltage (G-E SHORT)	V_{CES}	600	Volts
Gate-Emitter Voltage (C-E SHORT)	V_{GES}	± 20	Volts
Collector Current ($T_c = 25^\circ\text{C}$)	I_C	600	Amperes
Peak Collector Current ($T_j \leq 150^\circ\text{C}$)	I_{CM}	1200*	Amperes
Emitter Current** ($T_c = 25^\circ\text{C}$)	I_E	600	Amperes
Peak Emitter Current**	I_{EM}	1200*	Amperes
Maximum Collector Dissipation ($T_c = 25^\circ\text{C}$)	P_c	1420	Watts
Mounting Torque, M8 Main Terminal	–	95	in-lb
Mounting Torque, M6 Mounting	–	40	in-lb
Mounting Torque, M4 Terminal	–	15	in-lb
Weight	–	450	Grams
Isolation Voltage (Main Terminal to Baseplate, AC 1 min.)	V_{iso}	2500	Volts

Static Electrical Characteristics, $T_j = 25^\circ\text{C}$ unless otherwise specified

Characteristics	Symbol	Test Conditions	Min.	Typ.	Max.	Units
Collector-Cutoff Current	I_{CES}	$V_{CE} = V_{CES}, V_{GE} = 0V$	–	–	1	mA
Gate Leakage Voltage	I_{GES}	$V_{GE} = V_{CES}, V_{CE} = 0V$	–	–	80	μA
Gate-Emitter Threshold Voltage	$V_{GE(th)}$	$I_C = 60\text{mA}, V_{CE} = 10V$	5	6	7	Volts
Collector-Emitter Saturation Voltage	$V_{CE(sat)}$	$I_C = 600A, V_{GE} = 15V, T_j = 25^\circ\text{C}$	–	1.6	2.2	Volts
		$I_C = 600A, V_{GE} = 15V, T_j = 125^\circ\text{C}$	–	1.6	–	Volts
Total Gate Charge	Q_G	$V_{CC} = 300V, I_C = 600A, V_{GE} = 15V$	–	3720	–	nC
Emitter-Collector Voltage**	V_{EC}	$I_E = 600A, V_{GE} = 0V$	–	–	2.6	Volts

* Pulse width and repetition rate should be such that the device junction temperature (T_j) does not exceed $T_{j(max)}$ rating.

** Represents characteristics of the anti-parallel, emitter-to-collector free-wheel diode (FWDi).

CM600HU-12F
Trench Gate Design Single IGBTMOD™
 600 Amperes/600 Volts

Dynamic Electrical Characteristics, $T_j = 25\text{ }^\circ\text{C}$ unless otherwise specified

Characteristics	Symbol	Test Conditions	Min.	Typ.	Max.	Units
Input Capacitance	C_{ies}		–	–	160	nf
Output Capacitance	C_{oes}	$V_{CE} = 10V, V_{GE} = 0V$	–	–	11	nf
Reverse Transfer Capacitance	C_{res}		–	–	6	nf
Inductive	Turn-on Delay Time	$V_{CC} = 300V, I_C = 600A,$ $V_{GE1} = V_{GE2} = 15V,$	–	–	600	ns
Load	Rise Time					
Switch	Turn-off Delay Time	$R_G = 3.1\Omega,$ Inductive Load	–	–	900	ns
Times	Fall Time					
Diode Reverse Recovery Time**	t_{rr}	Switching Operation	–	–	300	ns
Diode Reverse Recovery Charge**	Q_{rr}	$I_E = 600A$	–	11.7	–	μC

Thermal and Mechanical Characteristics, $T_j = 25\text{ }^\circ\text{C}$ unless otherwise specified

Characteristics	Symbol	Test Conditions	Min.	Typ.	Max.	Units
Thermal Resistance, Junction to Case	$R_{th(j-c)Q}$	Per IGBT, T_C Reference Point per Outline Drawing	–	–	0.088	$^\circ\text{C/W}$
Thermal Resistance, Junction to Case	$R_{th(j-c)D}$	Per FWDi, T_C Reference Point per Outline Drawing	–	–	0.12	$^\circ\text{C/W}$
Thermal Resistance, Junction to Case	$R_{th(j-c)'Q}$	Per IGBT, T_C Reference Point Under Chip	–	0.04	–	$^\circ\text{C/W}$
Contact Thermal Resistance	$R_{th(c-f)}$	Per Module, Thermal Grease Applied	–	0.02	–	$^\circ\text{C/W}$

** Represents characteristics of the anti-parallel, emitter-to-collector free-wheel diode (FWDi).



Powerex, Inc., 200 Hillis Street, Youngwood, Pennsylvania 15697-1800 (724) 925-7272

CM600HU-12F
Trench Gate Design Single IGBTMOD™
 600 Amperes/600 Volts

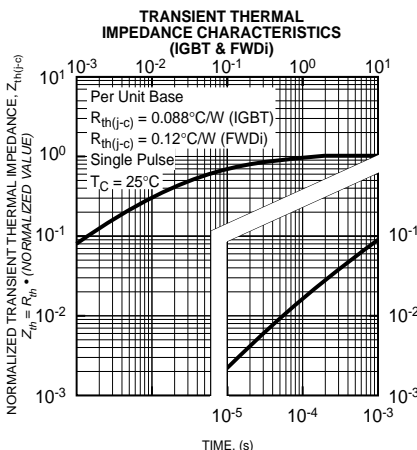
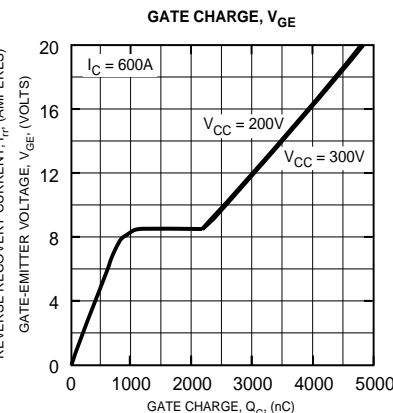
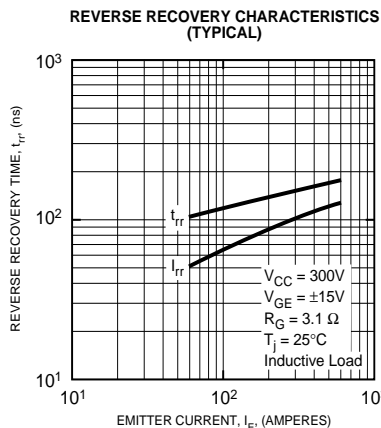
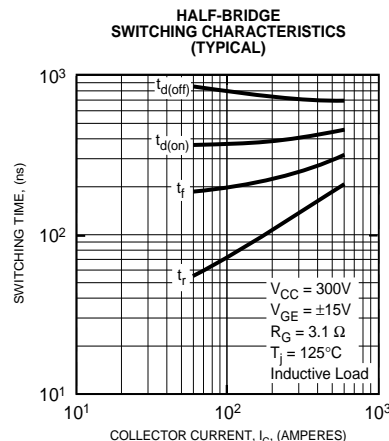
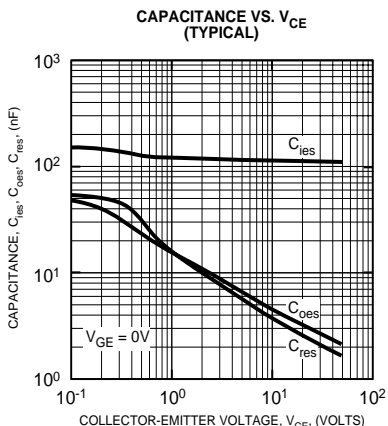
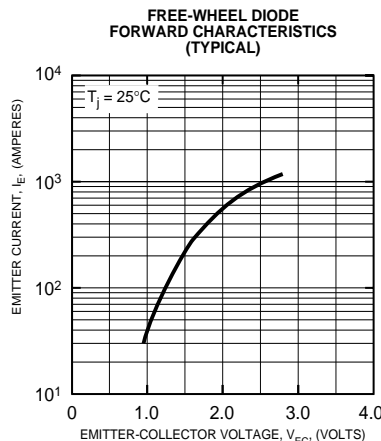
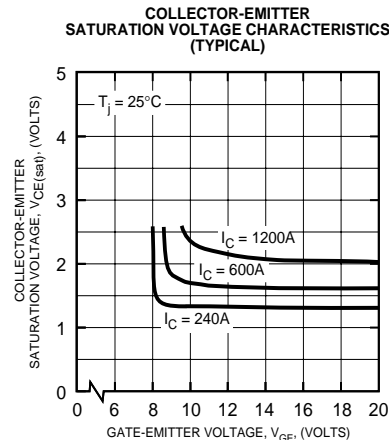
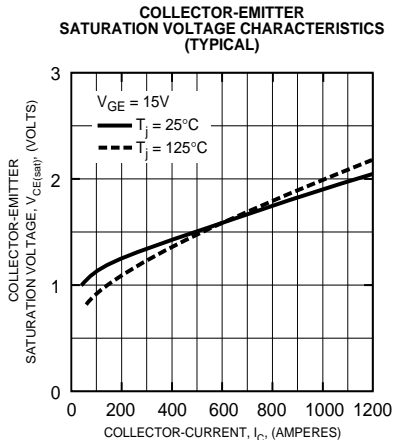
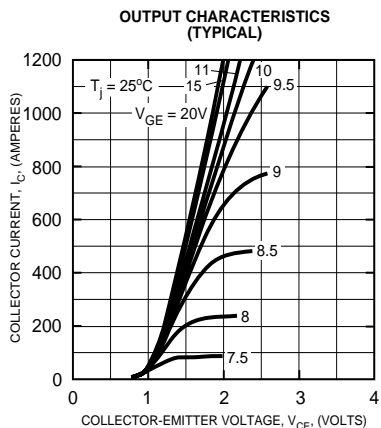

This datasheet has been download from:

www.datasheetcatalog.com

Datasheets for electronics components.